

PRODUCT NAME: SL125-150-EXPLOSION-PROOF- STATUS LIGHT/LAMP

DOC NO.: EX-TECH-SIG-SAS-12-SL125-150-TM-EN-REV04-10.08.16.IE

EXPLOSIONPROOF STATUS LIGHT/LAMP

 II 2GD

EPL Gb, Db

Ex d IIC T4/T5/T6 Gb, IP66/67

Ex tb IIIC Txxx

EX-TECH SIGNALLING SAS

SL125-150 EXPLOSIONPROOF STATUS LIGHT/LAMP

TECHNICAL MANUAL



Marking details;

Type :			
 0470  II 2 GD		ATEX 13 NEMKO 1565X IECEX, NEM 13.0035X CNEEx 10.2115X	
Ex d IIC T4 Gb Ex tb IIIC T135°C	IP 66		
T. amb: -40°C < Ta < +70°C		P	50/75/100/125 Watt max
		U	<input type="checkbox"/> VDC <input type="checkbox"/> AC50/60Hz
		Serial N° :	
WARNING - DO NOT OPEN WHEN AN EXPLOSIVE ATMOSPHERE IS PRESENT			
 Ex-tech Signalling SAS			
Ex-tech Signalling SAS, Champniers, France - www.ex-tech.no			

Alternative T class:

1;

Ex d IIC T5 Gb

Ex tb IIIC T100°C

T. amb: -40°C < Ta < +60°C

2:

Ex d IIC T4 Gb

Ex tb IIIC T135°C

T. amb: -40°C < Ta < +70°C

Please note that every care has been taken to ensure the accuracy of our technical manual. We do not, however, accept responsibility for damage, loss or expense resulting from any error or omission. We reserve the right to make alterations in line with technical advances and industry standards.

1.0 INTRODUCTION

SL series Explosion-proof status light/ lamp is designed for use in Oil & Gas, Offshore Platform, Chemical, Petrochemical, Refinery and Marine Industries etc. Enclosure material is Stainless Steel (BC 125) or GRP (BC 150). Different flash or rotary rate can be adjusted from unique design. Three working statuses-flash type, rotary type and steady type are available (LED).

There are 2 types of beacon (Xenon type and LED type) available for the customer.

2.0 EXPLOSION-PROOF LABELING

All products have a rating label, which carries the following important information:

Product order no.:

e.g. **SL150C40RXAXBX05GL05DCNNAR**

(Refer to the datasheet for product order selection) Input voltage: up to 48V DC or 100-254V AC

Code:

Exd IIC Txx Gb

Ex tb IIIC Txxx

ATEX Marking:

Gas Group and Category: II 2G

CE Mark: 

Warning: **DO NOT OPEN WHEN AN EXPLOSIVE GAS ATMOSPHERE IS PRESENT**

Finish product serial no.

Note: exact information is given on the actual label, ref also example on page 1.

Warning: **DO NOT OPEN WHEN AN EXPLOSIVE GAS ATMOSPHERE IS PRESENT**

3.0 TYPE APPROVAL STANDARD

The SL series products have been approved according the following standards:

IEC/EN 60079 General Requirements

IEC/ EN 60079-1 Flameproof Enclosure 'd'

IEC/ EN 60079-31 Dust atmosphere "t"

4.0 ZONES, GASGROUP, CATEGORY AND TEMPERATURE CLASSIFICATION

The SL series products have been certified Ex d IIC T4~T6. This means that the units can be installed in locations with the following conditions:

5.0 INSTALLATION

General Requirement

General Requirement

Selection, Installation, Maintenance and repair of electrical apparatus for use in potentially explosive atmosphere should be done in according to IEC/ EN 6079-14/ -17/ -19 . Product installation must be carried out in accordance with any local codes that may apply and should only be carried out by a competent electrical engineer.

Location

The location of the unit should be made with due regard to the area over which the warning signal must be visible and the manual call point/junction box can be easily operated. The unit should only be fixed to services that can carry the weight of the unit.

Mounting

The SL series of products should be mounted on a vertical surface via a stainless steel mounting plate (See Fig 1A/1B/1C/1D/1E). The fixing holes on the mounting plate are designed to fit M8 Allen Screw only. The diameter is 9mm. Use of stainless steel fastener is recommended by EX-TECH SAS.

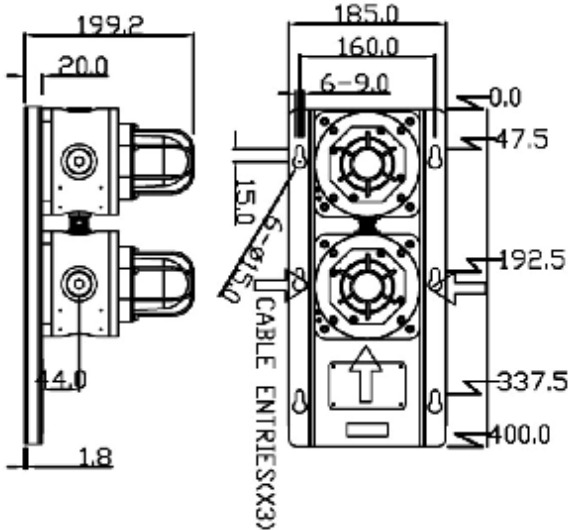

Fig 1A

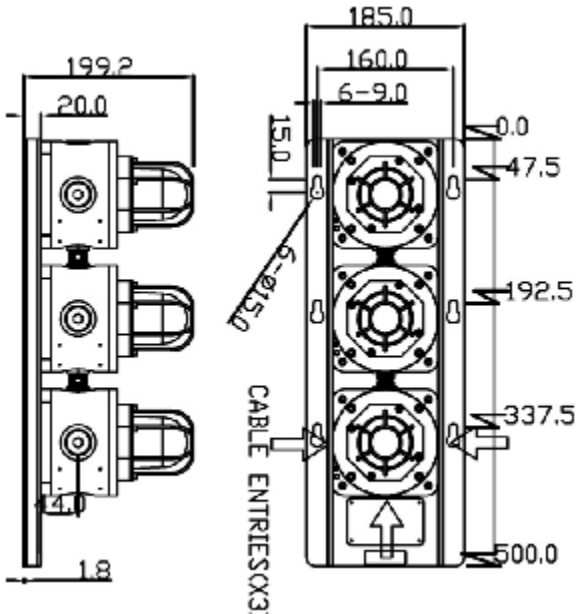

Fig 1B

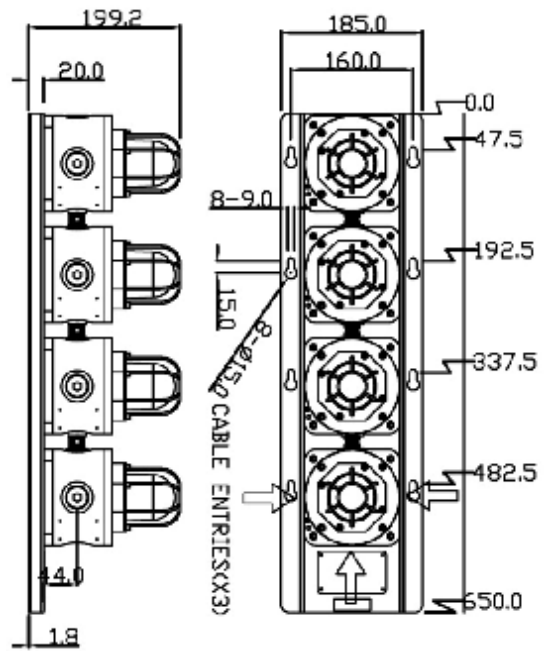

Fig 1C

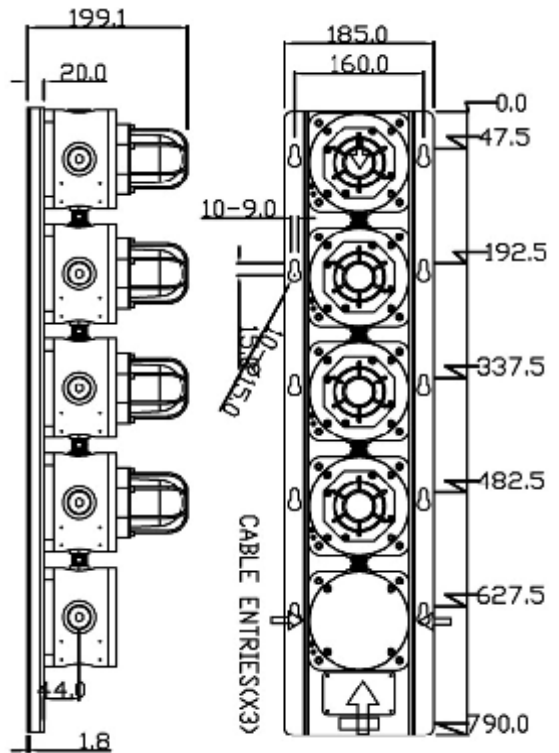

Fig 1D

The figures are related to SL 150

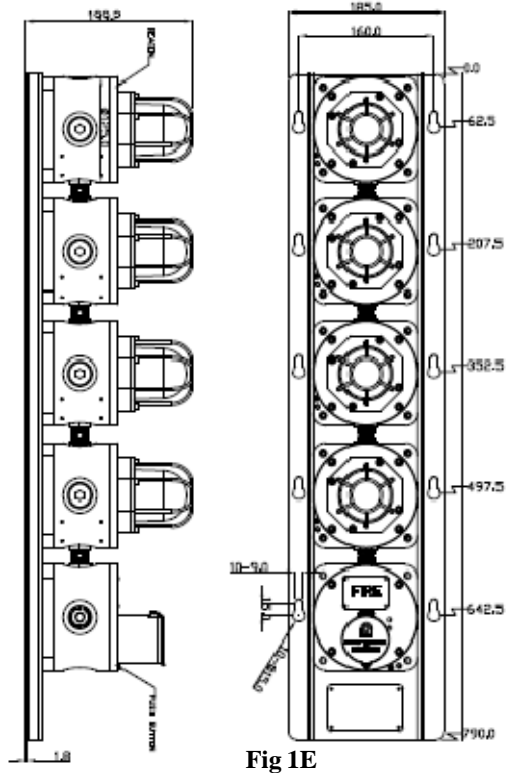

Fig 1E

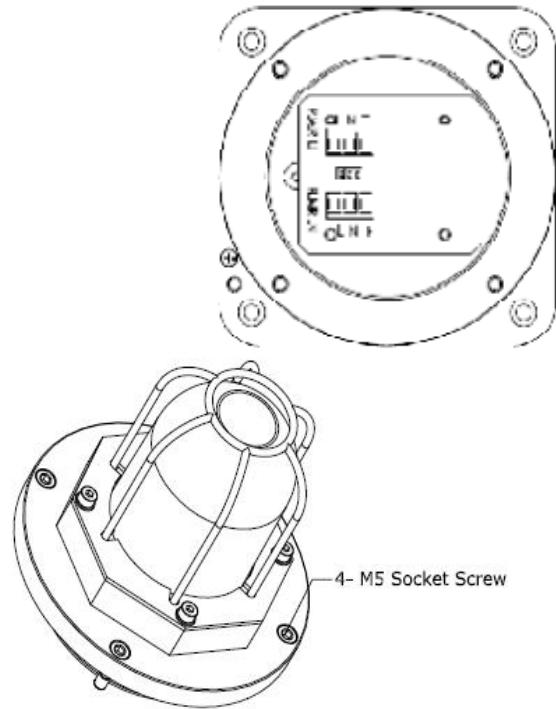

Fig 2

6.0 WIRING

General Requirement

EX-TECH SIGNALLING SAS recommends that all cables and cores should be fully identified (suggest using cable from 2.0 to 2.5 mm²). Ensure that all nuts, bolts and screws are secured. Ensure that only the right and certified cable glands are used and earthed correctly. Ensure that only the right and certified stopping plugs are used to blank off unused gland entry points. In order to maintain the IP rating of the product, we recommend SS316L for this application.

Cable Connection

The cable connection is connected with the terminal blocks assembly located in the flameproof enclosure of the bottom unit which can be **Beacon Component** (See Fig 2) or **Junction Box/Push Button**. Cable connection should be carried out in accordance with relevant technical requirement.

Remove End Cover (Beacon Component)

CAUTION: Before removing the cover, ensure the power to the product is isolated.

Unscrew the 4 (for SL 125) and 5 (for SL 150) M5 retained hex socket head screws to open the cover Beacon Component (See Fig 2). Twist the cover gently clockwise and anti-clockwise, whilst pulling away from the base, until it comes off.

Note; it recommended to open one blind plug to avoid internal vacuum in the unit.

This will release the cover from the base and allow the cover to hang on the retaining wire strap. Before replacing the cover, check that the flameproof joints are clean and not damaged, the gasket is still retained in its groove.

As lubrication/grease for the flameproof joint, a thin film of Acid free Vaseline (soap-thickened mineral oils) or mineral oil can be used, excessive lubrication/grease shall be removed before assembling.

Reinstall the cover in similar way, but operate in reverse manner as above.

Recommended Bolt Torque for M5 lid screws are 4.5 Nm.

Power Supply

Input voltage: up to 48V DC or 100-254V AC

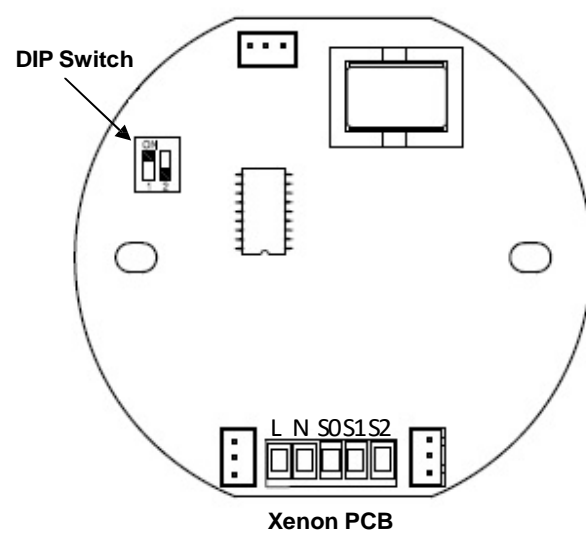
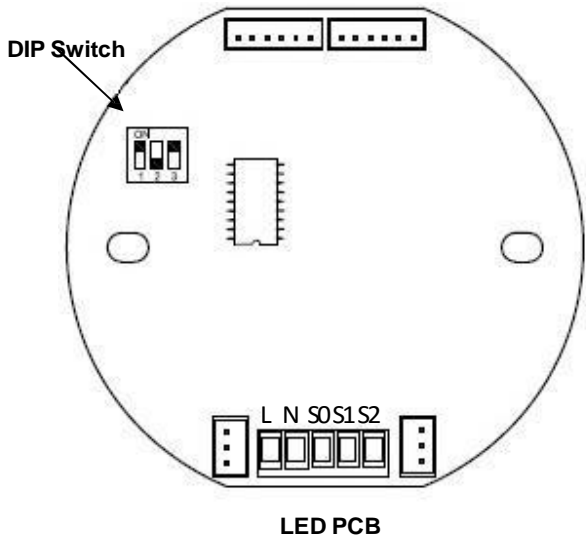

Fig 3

PCB Wiring Terminals (See Fig 3)

Apply power supply to 12V/24V/36V/48V DC 100-250V 'L' & 'N' (See Fig 3)

7.0 STATUS CHOSEN AND FLASHING FREQUENCY ADJUSTMENT

LED Beacon

The LED beacon provides flashing and rotary status to be selected

Use **DIP Switch** with 3 binary codes on the **LED Beacon PCB** to select flashing or rotary status (including steady status), the 3rd binary code is for high and low frequency chosen.

The Xenon Beacon provides flashing status

LED Status Selection Switch

1st & 2nd DIP Switch: ON=1, OFF=0;

3rd DIP Switch: HIGH= 1, LOW= 0

S1/S2: ON= Connect with 0/COM, OFF= Disconnect with 0/COM

DIP Switch			S1/S2	S1=OFF S2=OFF	S1=ON S2=OFF	S1=OFF S2=ON	S1=ON S2=ON
1 st DIP	2 nd DIP	3 rd DIP		Alarm Stage 1	Alarm Stage 2	Alarm Stage 3	Alarm Stage 4
0	0	0(1)		OFF	Flash 60 (75) times/min.	Flash 75 (90) times/min.	Steady
1	0	0(1)		OFF	Rotary 60 (75) times/min	Rotary 75 (90) times/min	Steady
0	1	0(1)		OFF	Triple Flash 60 (75) times/min.	Triple Flash 75 (90) times/min.	Triple Flash 100(120) times/min.
1	1	0(1)		OFF	Flash & Rotary 60 (75) times/min	Flash & Rotary 75 (90) times/min	Flash & Rotary 100(120) times/min

Xenon Beacon

Use **DIP Switch** with 2 binary codes on the **Xenon Beacon PCB** (see Fig 3) for frequency adjustment.

Xenon Beacon Flashing Frequency Adjustment

DIP Switch: ON=1, OFF=0

S1/S2: ON= Connect to COM, OFF= Disconnect to COM

S1/S2 DIP Switch		S1 = OFF S2 = OFF	S1 = ON S2 = OFF	S1 = OFF S2 = ON	S1 = ON S2 = ON
1	2	Alarm Stage 1	Alarm Stage 2	Alarm Stage 3	Alarm Stage 4
1	1	OFF	60 times/min (1)	90 times/min (1)	120 times/min (1)
0	1	OFF	60 times/min (2)	60 times/min (3)	60 times/min (4)
1	0	OFF	60 times/min (3)	60 times/min (4)	60 times/min (5)
0	0	OFF	60 times/min (4)	60 times/min (5)	60 times/min (6)

All the value in () are the number of flash by time

8.0 CABLE GLAND

The SL series of product has cable gland entries. Only cable glands approved for Ex 'd' applications can be used, which must be suitable for the type of cable being used and also meet the requirements of the Ex 'd' flameproof installation standard IEC/EN 60079-14.

SAFETY WARNING: If the SL products is used at high ambient temperatures, i.e. over +40°C, then the cable entry temperature may exceed +70°C and therefore suitable heat resisting cable glands must be used, with a rated service temperature of at least 95°C.

If a high IP (Ingress Protection) rating is required, a suitable sealing washer must be fitted under the cable gland.

When only one cable entry is used, the other one must be closed with an Ex 'd' flameproof blanking plug, which must be suitably approved for the installation requirements.

9.0 END OF LINE MONITORING

An end of line monitoring diode or an end of line monitoring resistor can be connected across the 24V+ and 0 terminals. If an end of line monitoring resistor is used, it must have a maximum resistance value of 3k ohms and a minimum wattage of 0.5 Watts; or a minimum resistance value of 1.2k ohms and a maximum wattage of 2 Watts.

10.0 MAINTENANCE

During working life of the product, little or no maintenance is required. Stainless Steel is resistant to most of the acids,

- i. This apparatus is suitable to be used only in ambient temperature as stated below at the label
- ii. Other than product manufacturer, painting and surface finishing are not permitted by the third party.
- iii. When used in dusty atmosphere, flameproof cable entry devices or stopping plugs have to be selected and installed carefully in order to maintain the IP rating

alkalis and chemicals.

If abnormal or unusual environmental conditions occur due to accident etc., visual inspection is recommended.

To avoid electrostatic charge build-up, only exterior of the product can be cleaned with a damp cloth.

If spare parts are required, these can be supplied by EX-TECH SIGNALLING SAS Company.

If any failure occurs but not caused by human factor, the product can be returned to EX-TECH SAS for free repair or replacement during warranty period.

11.0 CONDITIONS FOR SAFETY USE

This apparatus is suitable to be used only in ambient temperature as stated below:

Type	Ambient Temp.
SL-125/150	-40 to +70 °C

- i. Other than product manufacturer, painting and surface finishing are not permitted by the third party.
- ii. When used in dusty atmosphere, flameproof cable entry devices or stopping plugs have to be selected and installed carefully in order to maintain the IP rating (IP66/67) of the product.

Specific Condition for Use

Repairs of the flameproof joints must be made in compliance with the structural specifications provided by the manufacturer. Repairs must not be made on the basis of values specified in tables 1 and 2 of EN/IEC 60079-1.

Please contact Ex-Tech Signalling for further details

EX-TECH SIGNALLING SAS

ZA Les Montagnes

16430 CHAMPNIERS - FRANCE

Tel: +33 5 45 61 81 68

Fax: +33 5 45 23 29 46

Website: www.ex-tech.no

E-mail : sales.signalling@ex-tech.no

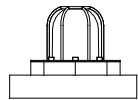

BEACON D

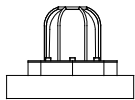

BEACON C/D

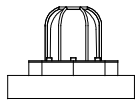

BEACON B/C

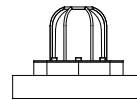

BEACON A/B

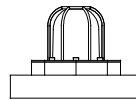

BEACON A

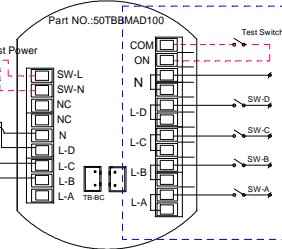
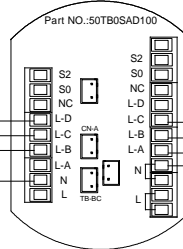
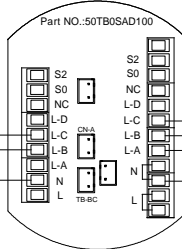
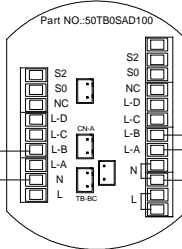
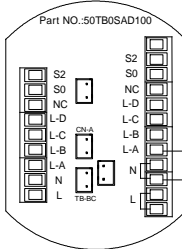
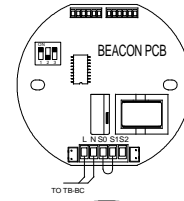
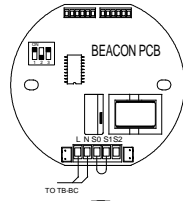
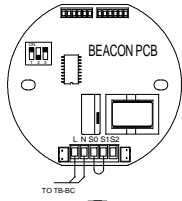
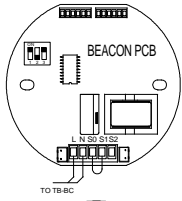
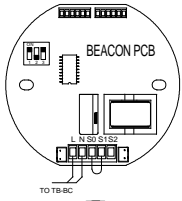

CT20 EXPLOSION CONNECTION

CT20 EXPLOSION CONNECTION

CT20 EXPLOSION CONNECTION

CT20 EXPLOSION CONNECTION

Wiring Method of Status Lights

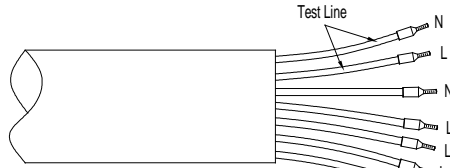
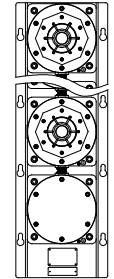
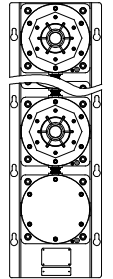

CABLE

Wiring For Customer

CAUTION OF WIRING AND FUNCTION:
FOR DC POWER SUPPLY:
 "L" EQUAL "B+", "N" EQUAL "0"
APPLY POWER SUPPLY
 AC 100~230V OR DC 12V~48V TO
 "L"&"N"
CONNECT SW-A TO START BEACON A
CONNECT SW-B TO START BEACON B
CONNECT SW-C TO START BEACON C
CONNECT SW-D TO START BEACON D

CONNECT TO Tel-1 & Tel-2 FOR TELE-INITIATION (OPTIONAL)

IF YOU NEED TO ADD A RESISTANCE, PLEASE CONNECT THE RESISTANCE BETWEEN "L" & "N"

TO ADJUST THE BEACON'S FLASHING FREQUENCY, PLEASE REFER TO THE INSTRUCTION IN THE PRODUCT'S TECHNICAL MANUAL.

DO NOT SUPPLY AC OR DC POWER TO S0/S1/S2/Dly.

Cable Selection

Please select suitable size cable according to the distance between control room & the terminals and the quantity of equipments used.

Normal size for AC power supply cable L & N is 1.5mm². Normal size for DC power supply cable L & N is 2.5mm².

Please select the quantity of control cables (2 to 7) according to the actual requirement. Normal size for control cable is 1mm².

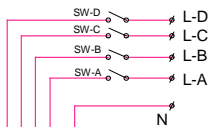
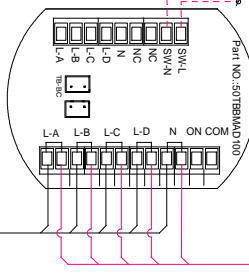
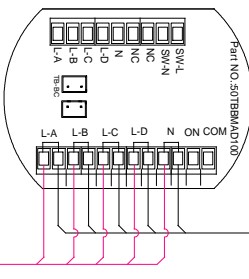

00 - 01/10/2015	Creation		
Revision - date	Reason		
Material			
Treatment			
Specifications			
Drawing part		Scale: 1:1	Project / N° PO
WIRING BOARD SL100/125/150		Drawn by: P. TRAUMAT	Dossier
Date: 01/10/2015	SL100_125_150	N° Drawing	Index
			Folio 01 / 1/1



Size: A3

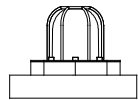

BEACON D

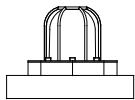

BEACON C/D

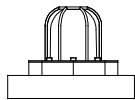

BEACON B/C

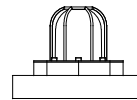

BEACON A/B



JUNCTION BOX

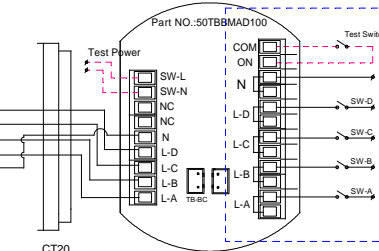
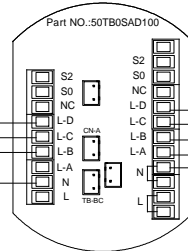
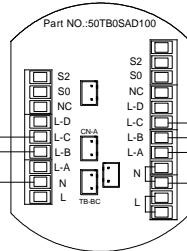
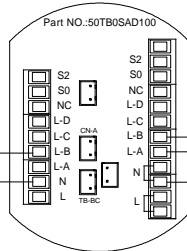
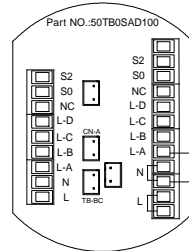
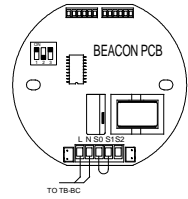
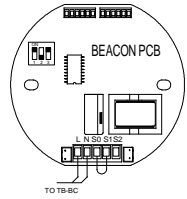
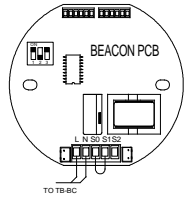
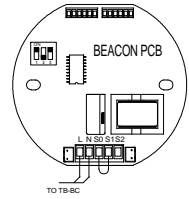

CT20 EXPLOSION CONNECTION

CT20 EXPLOSION CONNECTION

CT20 EXPLOSION CONNECTION

CT20 EXPLOSION CONNECTION

Wiring Method of Status Lights

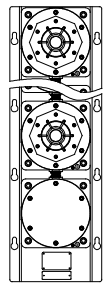
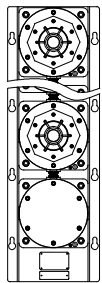

Test Power

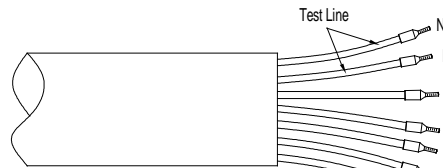

CABLE

Wiring For Customer

CAUTION OF WIRING AND FUNCTION:

FOR DC POWER SUPPLY: "L" EQUAL "B+", "N" EQUAL "0"

APPLY POWER SUPPLY AC 100-230V OR DC 12V-48V TO "L"&"N"

- CONNECT SW-A TO START BEACON A
- CONNECT SW-B TO START BEACON B
- CONNECT SW-C TO START BEACON C
- CONNECT SW-D TO START BEACON D

CONNECT TO Tel-1 & Tel-2 FOR TELE-INITIATION (OPTIONAL)

IF YOU NEED TO ADD A RESISTANCE, PLEASE CONNECT THE RESISTANCE BETWEEN "L" & "N"

TO ADJUST THE BEACON'S FLASHING FREQUENCY, PLEASE REFER TO THE INSTRUCTION IN THE PRODUCT'S TECHNICAL MANUAL.

DO NOT SUPPLY AC OR DC POWER TO S0/S1/S2/Dly.

Cable Selection

Please select suitable size cable according to the distance between control room & the terminals and the quantity of equipments used.

Normal size for AC power supply cable L & N is 1.5mm². Normal size for DC power supply cable L & N is 2.5mm².

Please select the quantity of control cables (2 to 7) according to the actual requirement. Normal size for control cable is 1mm².

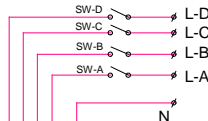
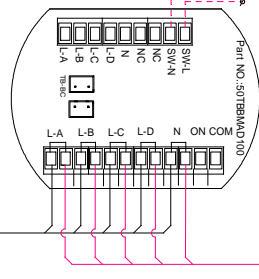
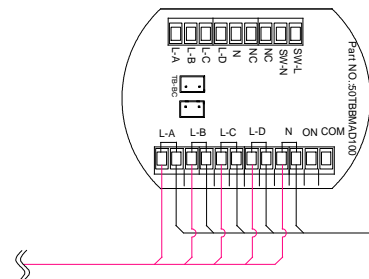

00 - 01/10/2015	Creation		
Revision - date	Reason		
Material			
Treatment			
Specifications			
Drawing part		Scale: 1 : 1	Project / N° PO
WIRING DIAGRAM SL100/125/150 WITH JB		Drawn by: P. TRAUMAT	Dossier
Date: 01/10/2015		N° Drawing	Index
		SL100_125_150_JB	Folio 01 / 1/1



Size: A3

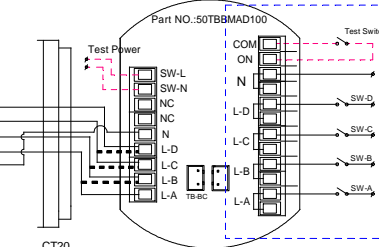
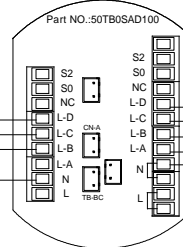
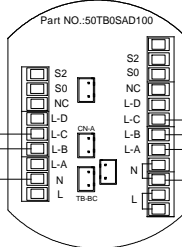
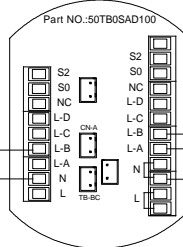
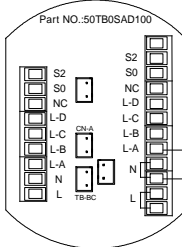
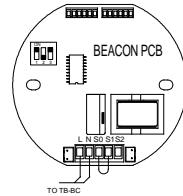
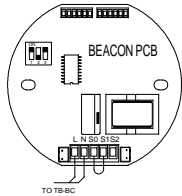
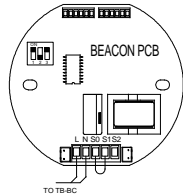
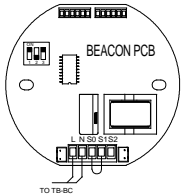
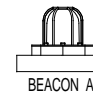
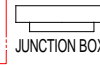
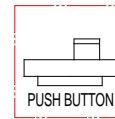
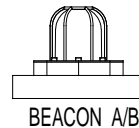
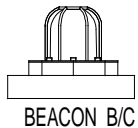
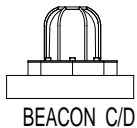
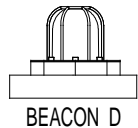

CT20 EXPLOSION CONNECTION

CT20 EXPLOSION CONNECTION

CT20 EXPLOSION CONNECTION

CT20 EXPLOSION CONNECTION

CAUTION OF WIRING AND FUNCTION:
FOR DC POWER SUPPLY:
 "L" EQUAL "B+", "N" EQUAL "0"
APPLY POWER SUPPLY
 AC 100-230V OR DC 12V-48V TO
 "L" & "N"
CONNECT SW-A TO START BEACON A
CONNECT SW-B TO START BEACON B
CONNECT SW-C TO START BEACON C
CONNECT SW-D TO START BEACON D

CONNECT TO Tel-1 & Tel-2 FOR TELE-INITIATION (OPTIONAL)
IF YOU NEED TO ADD A RESISTANCE, PLEASE CONNECT THE RESISTANCE BETWEEN "L" & "N"
TO ADJUST THE BEACON'S FLASHING FREQUENCY, PLEASE REFER TO THE INSTRUCTION IN THE PRODUCT'S TECHNICAL MANUAL.
DO NOT SUPPLY AC OR DC POWER TO S0/S1/S2/Dly.

Wiring For Customer

Wiring Method of Status Lights

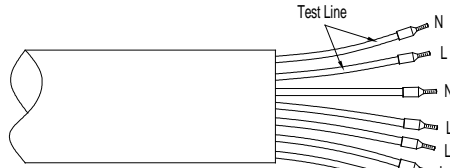
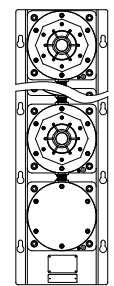
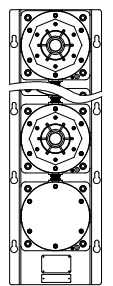

CABLE

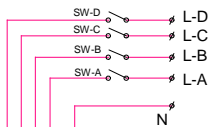
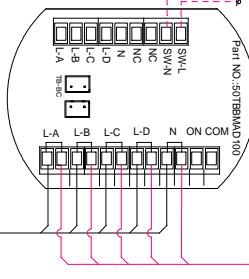
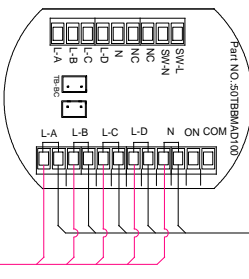

00 - 01/10/2015	Creation		
Revision - date	Reason		
Material			
Treatment			
Specifications			
Drawing part		Scale: 1:1	Project / N° PO
WIRING BOARD SL100/125/150 WITH PB		Drawn by: P. TRAUMAT	Dossier
Date: 01/10/2015		N° Drawing	Index
		SL100_125_150_PB	Folio 01 / 1/1

Cable Selection

Please select suitable size cable according to the distance between control room & the terminals and the quantity of equipments used.

Normal size for AC power supply cable L & N is 1.5mm². Normal size for DC power supply cable L & N is 2.5mm².

Please select the quantity of control cables (2 to 7) according to the actual requirement. Normal size for control cable is 1mm².

